

## We take a new look at gutters!

STEEL SQUARE GUTTER SYSTEM • STEEL GUTTER SYSTEMS • PVC GUTTER SYSTEMS  
PVC SQUARE GUTTER SYSTEM • HIDDEN GUTTER SYSTEM • PVC ROOF SOFFIT



**KROP**

[WWW.KROPSYSTEM.EU](http://WWW.KROPSYSTEM.EU)



## STEEL SQUARE gutter system

---

SYSTEM  
135/80x80



## STEEL / Steel AZ gutter systems

---

SYSTEM  
125/90

SYSTEM  
130/90

SYSTEM  
130/100

SYSTEM  
150/100

SYSTEM  
150/120



## PVC SQUARE gutter system

---

SYSTEM  
135/80x80



## PVC gutter systems

---

SYSTEM  
75/63

SYSTEM  
100/63

SYSTEM  
100/90

SYSTEM  
130/90



## PVC / STEEL gutter system

---

SYSTEM  
SRU



## PVC roof soffit

---

SOFFIT  
WOOD-LIKE

SOFFIT  
TRADITIONAL



**BLACK**  
(RAL 9005)



**GRAPHITE**  
(RAL 7016)

SYSTEM  
135/80X80

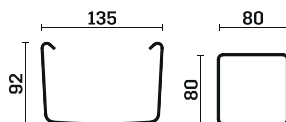

**STEEL**



**PEACE OF MIND GUARANTEED**

UP TO 50-YEAR guarantee against perforation due to corrosion of the KROP STEEL Square Gutter System

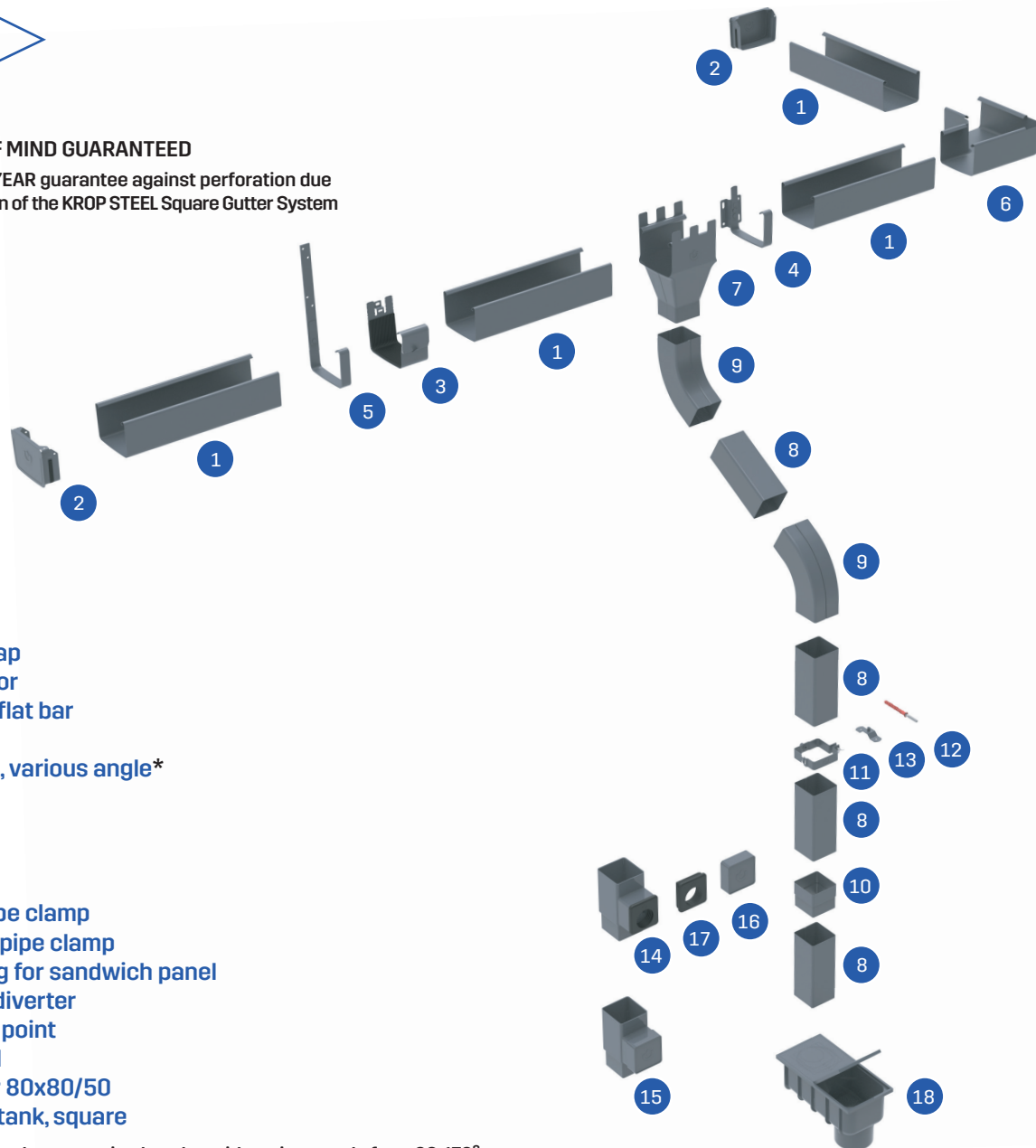

1. Square gutter
2. Universal endcap
3. Gutter connector
4. Fascia bracket flat bar
5. Rafter bracket
6. Universal angle, various angle\*
7. Outlet
8. Square pipe
9. Elbow
10. Pipe connector
11. Steel square pipe clamp
12. Dowel for steel pipe clamp
13. Clamp mounting for sandwich panel
14. PVC rainwater diverter
15. PVC inspection point
16. Plug with a seal
17. Rubber reducer 80x80/50
18. Sedimentation tank, square

\* On special request, we make customized angles with various angle from 80-179°.

**Functionality  
in unobtrusive style**

■ SQUARE GUTTER SYSTEM



**KROP**  
SQUARE GUTTER SYSTEM





**SYMMETRICAL GUTTER**

The symmetrical shape of the gutter makes installation of long elements simple and efficient.



**UNIVERSAL FITTINGS - 2 IN 1**

The symmetrical gutter fittings ensure intuitive installation of the system.



**REINFORCED SUPPORTING ELEMENTS MADE OF STEEL**

They ensure high stability of the gutter system.



**DEEP GUTTER**

The 135/80x80 square gutter system ensures the best performance on the market.



**HIGH DURABILITY**

A very high quality material ensuring high resistance to mechanical damage and scratching.



**PROTECTIVE LAYERS**

A steel gutter has four protective layers ensuring higher resistance to adverse weather conditions and resistance to mechanical damage.



**CORROSION RESISTANCE**

Thanks to the use of top quality steel and protective layers, the system features very high corrosion-resistance.



**EASY TO INSTALL**

The simple and lightweight form of the system makes work on the roof faster and easier.



**SIMPLE DESIGN**

Perfectly integrated into the body of the building - this is an aesthetic finish to the roof.



**PRO-ENVIRONMENTAL DESIGN**

Manufacturing in the spirit of LESS WASTE is an environmentally friendly process.



**PEACE OF MIND GUARANTEED**

**UP TO 50-YEAR** guarantee against perforation due to corrosion of the KROP STEEL Square Gutter System.



**READY-MADE PACKAGE OF MATERIALS FOR THE ARCHITECT**

A complete library of CAD drawings.  
**DOWNLOAD: [WWW.KROPSYSTEM.EU](http://WWW.KROPSYSTEM.EU)**

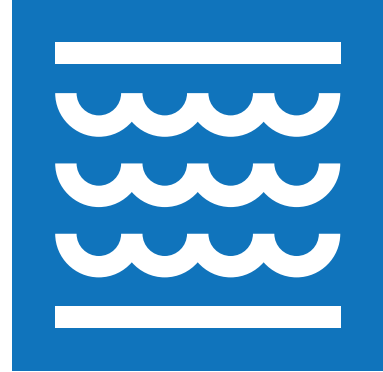
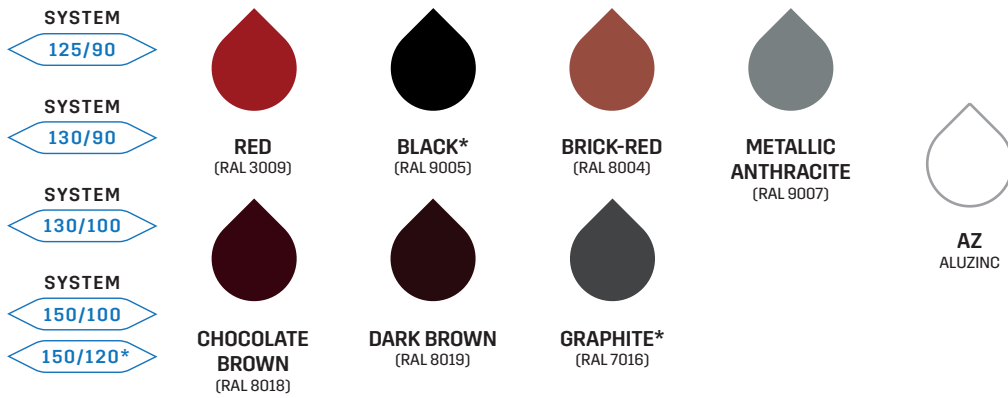

**STEEL**

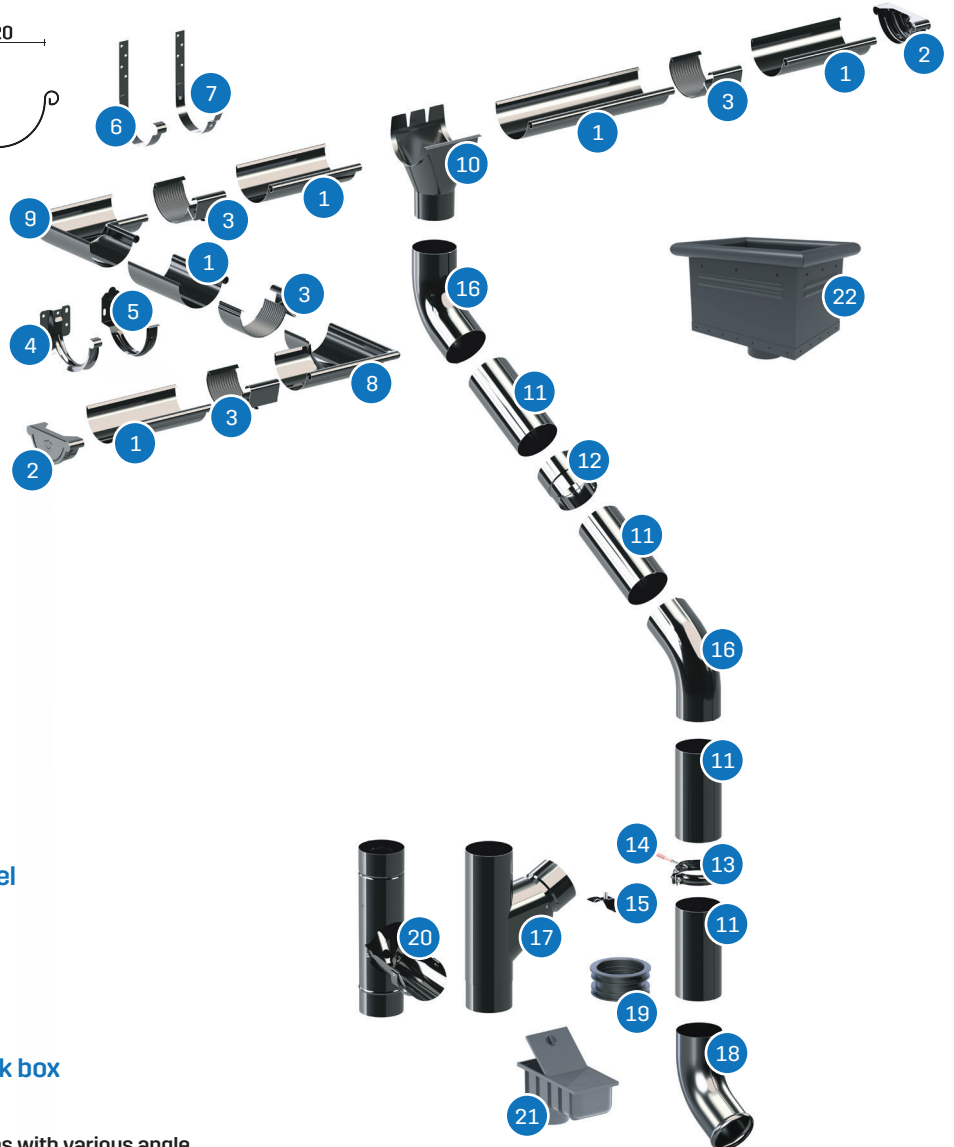
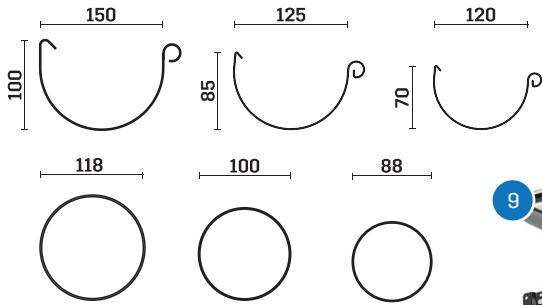

1. Gutter
2. Universal endcap
3. Gutter connector
4. Fascia bracket
5. Fascia bracket flat bar
6. Rafter bracket
7. Rafter bracket BB
8. 90° External angle \*\*
9. 90° Internal angle \*\*
10. Outlet
11. Pipe
12. Pipe connector
13. Pipe clamp
14. Clamp dowel
15. Clamp mounting for sandwich panel
16. Elbow
17. Y-Branch
18. Shoe
19. 90/110 Rubber reducer
20. Rainwater diverter
21. Sedimentation tank / Universal sink box
22. Outlet basket

\*\* On special request,, we make customized angles with various angle.

# STEEL gutter systems

UP TO 40 YEARS OF WARRANTY



**KROP**  
GUTTER SYSTEMS

STEEL

**UP TO 40 YEARS OF WARRANTY**

Product with proven performance characteristics.

**MECHANICAL RESISTANCE**

Based on tests and analyses, the product features very high resistance to mechanical damage.

**HIGH DURABILITY**

A very high quality material ensuring high resistance to mechanical damage and scratching.

**EASY INSTALLATION**

The system designed with attention to detail enables quick and efficient installation. The solution has been designed in cooperation with roofers.

**PROTECTIVE LAYERS**

A steel gutter has four protective layers ensuring higher resistance to adverse weather conditions and resistance to mechanical damage.

**VERSATILITY**

Fits all types of roofing.

**CORROSION RESISTANCE**

Thanks to the use of top quality steel and protective layers, the system features very high corrosion-resistance.

**HIGH RESILIENCE**

Resistant to deformation under external conditions.



SYSTEM  
135/80X80

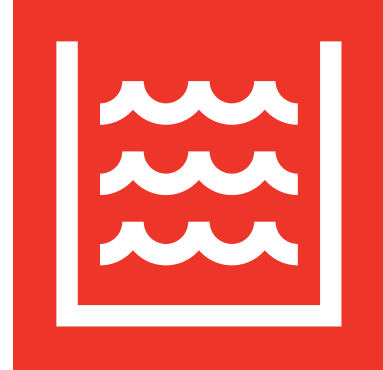
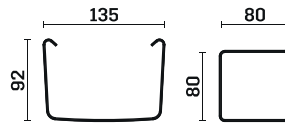

PVC



**LONGEST WARRANTY ON THE MARKET**  
UP TO 30 YEARS - guarantee in terms of mechanical durability of the KROP PVC Concealed Gutter System.

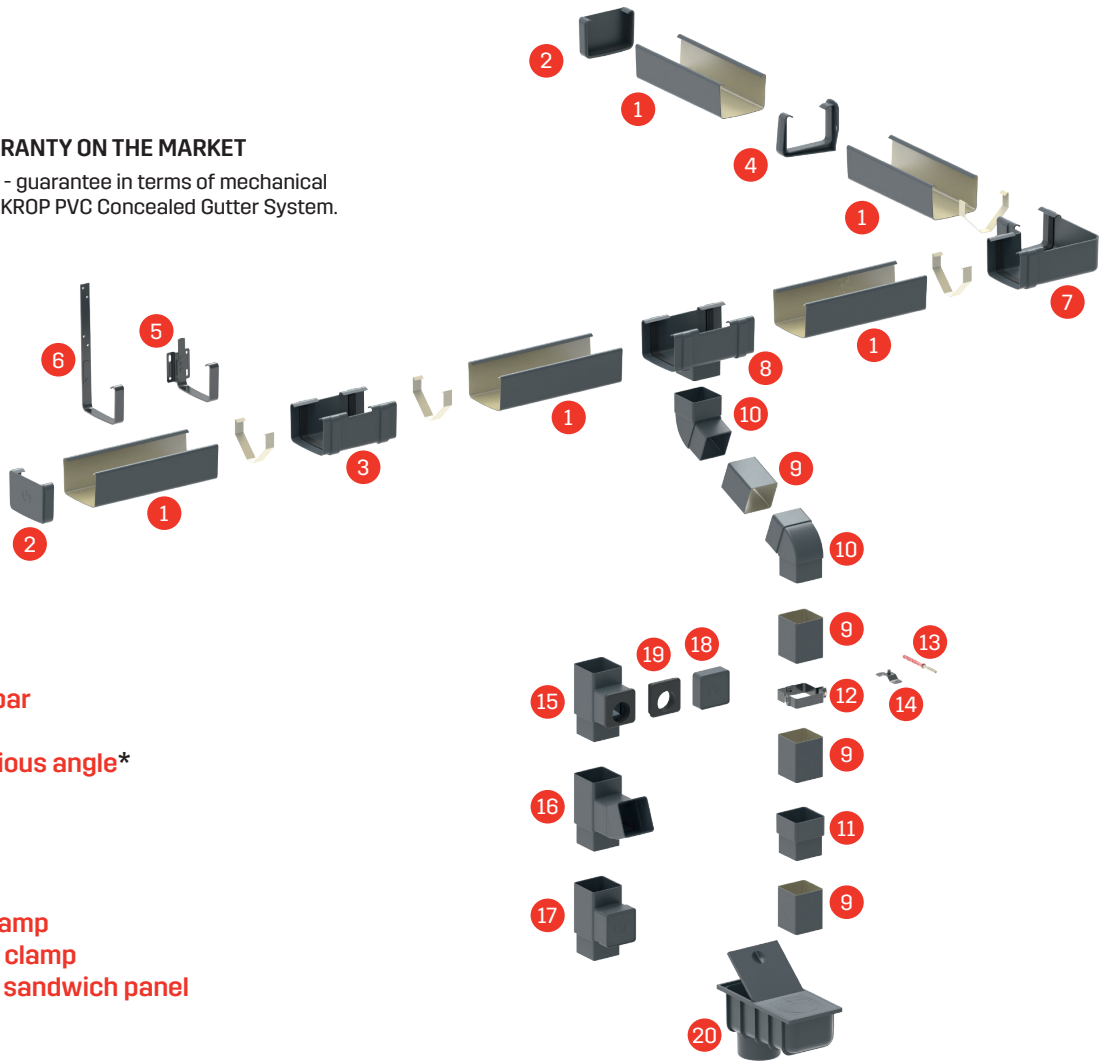

1. Square gutter
2. Universal endcap
3. Gutter connector
4. Fascia bracket PVC
5. Fascia bracket flat bar
6. Rafter bracket
7. Universal angle, various angle\*
8. Outlet
9. Square pipe
10. Elbow
11. Pipe connector
12. Steel square pipe clamp
13. Dowel for steel pipe clamp
14. Clamp mounting for sandwich panel
15. Rainwater diverter
16. Y-Branch
17. Inspection element
18. Plug with a seal
19. Rubber reducer 80x80/50
20. Sedimentation tank, square

\* On special request, we make customized angles with various angle from 50-179°.

A friendly system  
for modern houses

■ SQUARE GUTTER SYSTEM



**KROP**  
SQUARE GUTTER SYSTEM

PVC

PVC

## ADVANTAGES OF THE KROP SQUARE GUTTER SYSTEM



### SYMMETRICAL GUTTER

The symmetrical shape of the gutter makes installation of long elements simple and efficient.



### SYMMETRICAL 2-IN-1 FITTINGS

The symmetrical gutter fittings ensure intuitive installation of the system.



### SUPPORTING ELEMENTS MADE OF STEEL

They ensure high stability of the gutter system.



### HIGH PERFORMANCE

The 135/80x80 square system provides efficient water collection.



### PERFECT TIGHTNESS

A specially selected gasket guarantees high tightness during heavy rainfall.



### PERFECT FINISH

The perfect fit of the components ensures easy installation.



### LIGHTWEIGHT AND EASY TO INSTALL

The simple and lightweight form of the system makes work on the roof faster and easier.



### SIMPLE DESIGN

Perfectly integrated into the body of the building - this is an aesthetic finish to the roof.



### RECYCLING

The recycling mix is a thoughtful strategy of the KROP brand's environmental activity.



### PRO-ENVIRONMENTAL DESIGN

Manufacturing in the spirit of LESS WASTE is an environmentally friendly process.



### LONGEST WARRANTY ON THE MARKET

**UP TO 30 YEARS** - guarantee in terms of mechanical durability of the KROP PVC Concealed Gutter System.



### READY-MADE PACKAGE OF MATERIALS FOR THE ARCHITECT

A complete library of CAD drawings.  
**DOWNLOAD: [WWW.KROPSYSTEM.EU](http://WWW.KROPSYSTEM.EU)**

SYSTEM  
75/63

SYSTEM  
100/63

SYSTEM \*  
100/90

SYSTEM \*\*  
130/90



**BLACK**  
(RAL 9005)



**DARK BROWN**  
(RAL 8019)



**LIGHT BROWN**  
(RAL 8017)



**GRAPHITE**  
(RAL 7016)



**WHITE**  
(RAL 9010)  
\* 100/90  
\*\* 130/90



**RED**  
(RAL 3011)  
\*\* 130/90

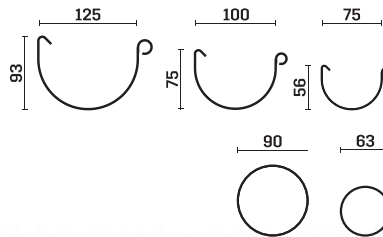

PVC

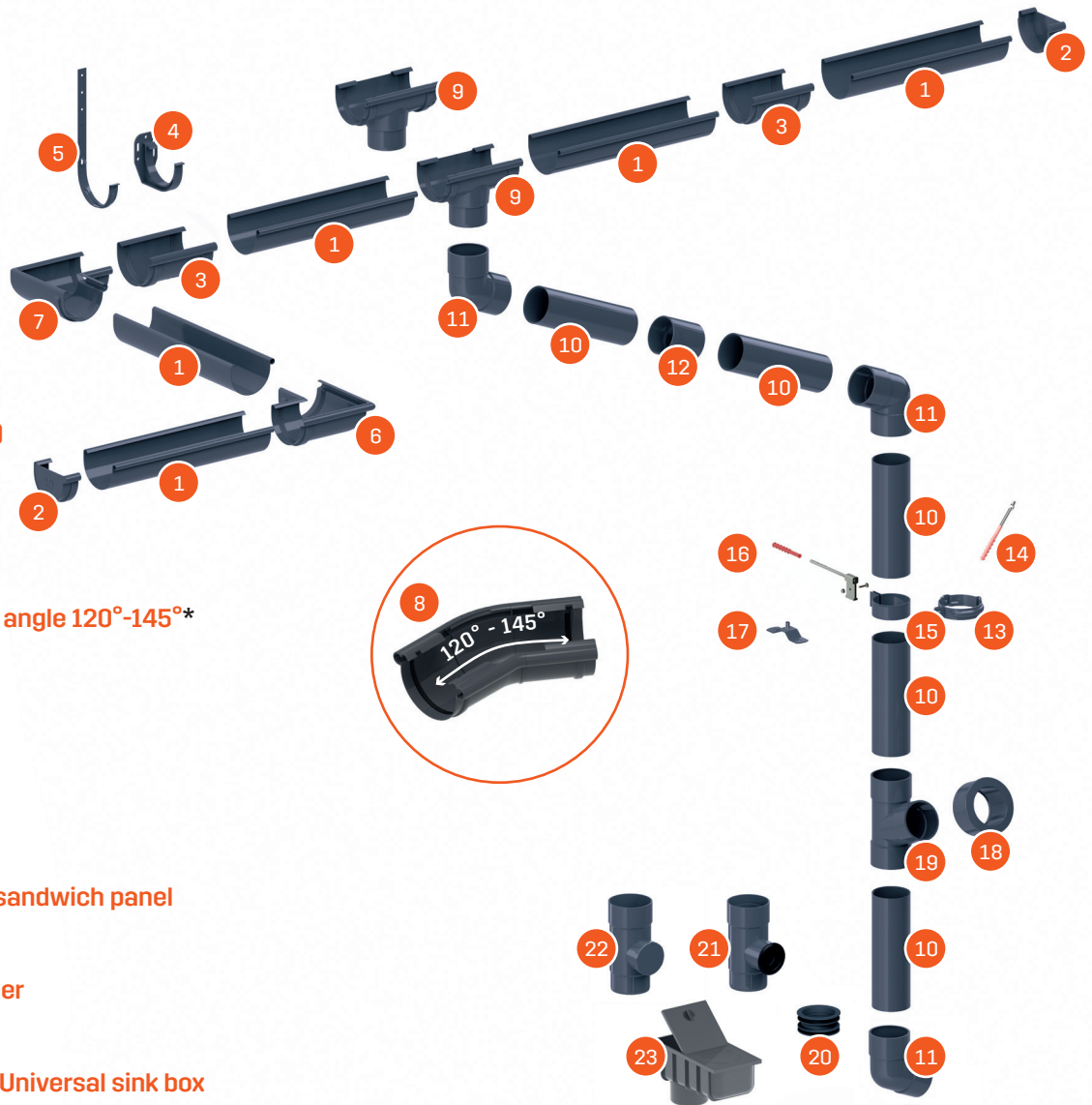

1. Gutter
2. Endcap (RIGHT/LEFT)
3. Gutter connector
4. Fascia bracket
5. Rafter bracket
6. 90° External angle
7. 90° Internal angle
8. Universal adjustable angle 120°-145°\*
9. Outlet
10. Pipe
11. Elbow
12. Pipe connector
13. Pipe steel clamp
14. Steel clamp dowel
15. Pipe PVC clamp
16. PVC Clamp dowel
17. Clamp mounting for sandwich panel
18. 90/63 Reducer
19. Y-Branch
20. 90/110 Rubber reducer
21. Rainwater diverter
22. Inspection element
23. Sedimentation tank/Universal sink box

\* 130 KROP PVC gutter system

# PVC gutter systems

UP TO 20-YEAR WARRANTY



**KROP**

GUTTER SYSTEMS

PVC

**UP TO 20-YEAR WARRANTY**

Product with proven performance characteristics. It is one of the longest guarantee periods available on the market.

**ENVIRONMENTALLY-FRIENDLY**

The material can be recycled and reused.

**PERFECT WATER-TIGHTNESS**

A special multi-lip seal, developed in cooperation roofers, ensures reliability regardless of the weather.

**EFFICIENCY**

Excellent value for money.

**LIGHTWEIGHT AND EASY TO INSTALL**

Lightweight material does not strain the structure while innovative system components additionally make installation easier.

**HIGH DURABILITY**

A very high quality material ensuring high resistance to mechanical damage and scratching.

**RESISTANT TO UV RADIATION**

Retains durable colour for years.

**PRO-ENVIRONMENTAL DESIGN**

Manufacturing in the spirit of LESS WASTE is an environmentally friendly process.



**BLACK**  
(RAL 9005)



**GRAPHITE**  
(RAL 7016)

**SYSTEM**  
**SRU**

**REINFORCED FASCIA**  
**COLORS**



**UP TO 40 YEARS**

Warranty against perforation by rust for REINFORCED FASCIA. This is the longest warranty on the market.



**UP TO 10 YEARS**

Guarantee of the system water tightness during installation of KROP PVC pipe in the facade.

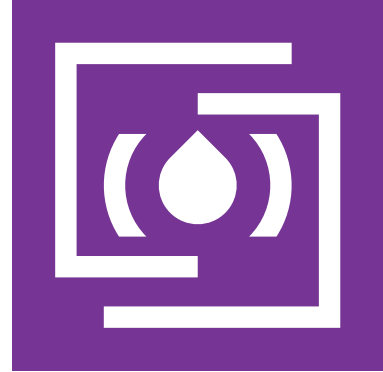

**STEEL/PVC**

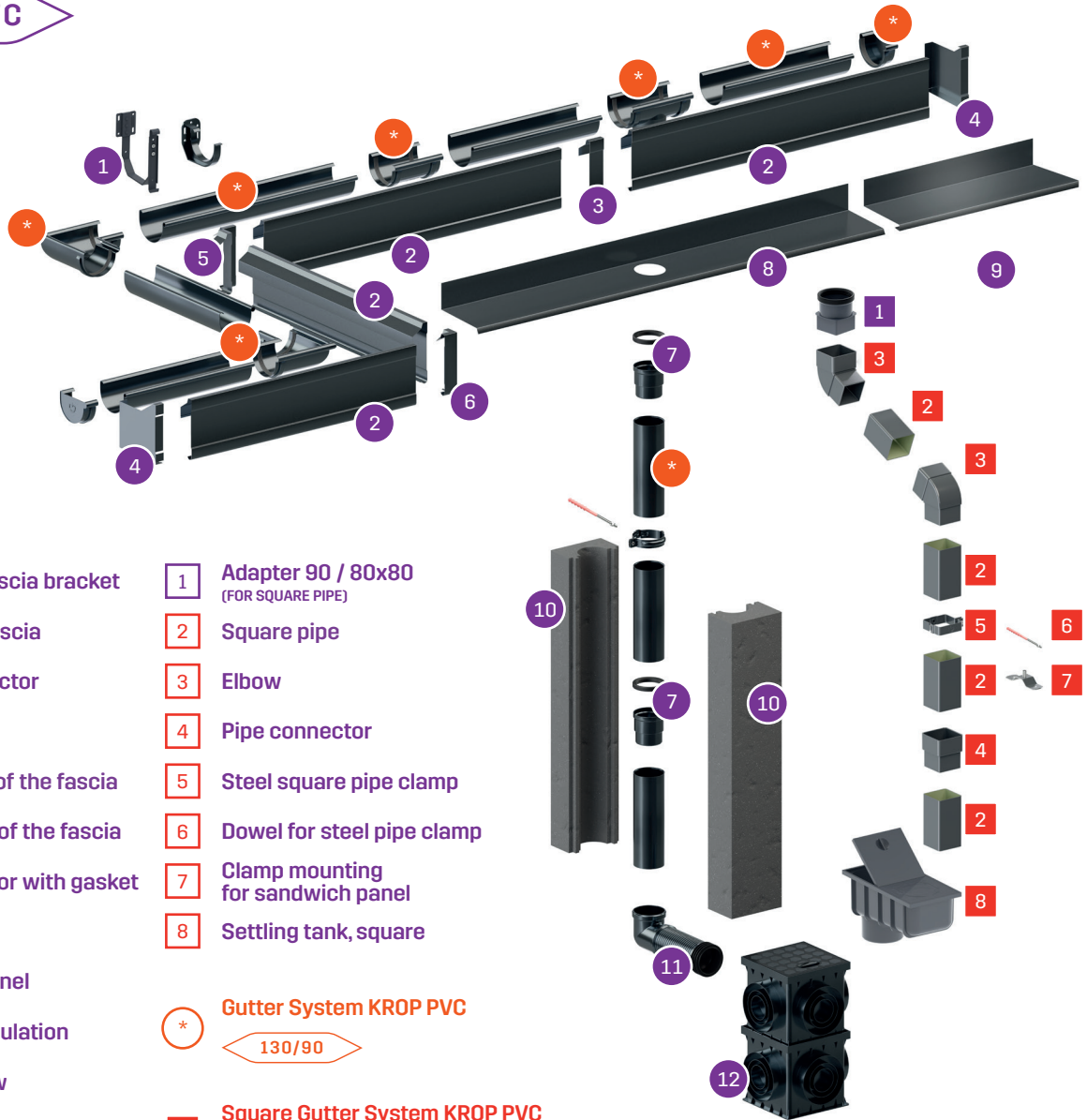

- 1 Adjustable fascia bracket
- 2 Reinforced fascia
- 3 Fascia connector
- 4 Fascia plug (RIGHT/LEFT)
- 5 Inner corner of the fascia
- 6 Outer corner of the fascia
- 7 Pipe connector with gasket
- 8 Verge trim
- 9 Roof soffit panel
- 10 Downpipe insulation
- 11 Flexible elbow
- 12 Inspection pit

- 1 Adapter 90 / 80x80 (FOR SQUARE PIPE)
- 2 Square pipe
- 3 Elbow
- 4 Pipe connector
- 5 Steel square pipe clamp
- 6 Dowel for steel pipe clamp
- 7 Clamp mounting for sandwich panel
- 8 Settling tank, square

- \* Gutter System KROP PVC
  - 130/90
- Square Gutter System KROP PVC
  - 135/80x80

# Traditional craftsmanship in a modern form

■ HIDDEN GUTTER SYSTEM



**KROP**

HIDDEN GUTTER SYSTEM

STEEL/PVC



#### THE SIMPLEST INSTALLATION OF A HIDDEN GUTTER SYSTEM ON THE MARKET

Developed with master roofers and based on their best practices.

Special calculator for easy installation: [WWW.KROPSYSTEM.EU](http://WWW.KROPSYSTEM.EU)



#### ADJUSTABLE FASCIA BRACKET

It ensures the installation and leveling of the fascia regardless of the slope of the gutter system.



#### AESTHETIC REINFORCED FASCIA WITH THICKNESS OF 0.7 MM

Adjusted to the latest trends of houses without eaves. The specially designed profile of the reinforced fascia ensures that there is no ripple effect.



#### CLASSICAL INSTALLATION ACCORDING TO THE ART OF ROOFING

Thanks to the use of a proven profile of KROP semi-circular gutter, the installation of the system runs smoothly and according to known roofing standards.



#### FASCIA PROFILE WITH SPECIAL PROTECTION

It prevents precipitation from entering between the fascia and gutter.



#### ROOF SOFFIT PANEL FOR CLASSIC INSTALLATION IN A HOUSE WITH EAVES

It allows an aesthetic installation of the soffit panel and the downpipe.



#### VENTILATION GAP

It allows to maintain proper roof ventilation, thanks to the vertical adjustment of the fascia on the bracket.



#### PERFECT WATER-TIGHTNESS

The proven solution for sealing and connecting the gutter to the downpipe (pipe connector with gasket), eliminates the risk of leakage in the system.



#### THE LONGEST WARRANTY AVAILABLE ON THE MARKET

**UP TO 40 YEARS** - warranty against perforation corrosion KROP STEEL

**UP TO 20 YEARS** - warranty for mechanical durability KROP PVC.

**UP TO 30 YEARS** - warranty for mechanical durability of the square riser PVC 80x80

**UP TO 10 YEARS** - leakproof warranty for the KROP HIDDEN GUTTER SYSTEM



#### PROVEN PERFORMANCE

Using a classic KROP gutter system ensures efficient rainwater drainage.



#### READY MATERIAL PACKAGE FOR ARCHITECT

A complete library of CAD drawings ensures that the system may be quickly entered into the design by the architect.



#### APPLICATION TO FACILITATE CORRECT INSTALLATION

Special calculator to facilitate correct positioning of the hidden gutter system in relation to the roof plane. Check out! [WWW.KROPSYSTEM.EU](http://WWW.KROPSYSTEM.EU)



## COMPONENT

## DIMENSION PIECES/ IN PACKAGING

<b>FULL ROOF SOFFIT</b>	3000 x 305 mm ~ 0,91 m <sup>2</sup> 18 / 16,47 m <sup>2</sup>
<b>PERFORATED ROOF SOFFIT</b>	3000 x 305 mm ~ 0,91 m <sup>2</sup> 18 / 16,47 m <sup>2</sup>
<b>J MOUNTING RAIL</b>	3000 mm 40 / 120 RMT
<b>H MOUNTING RAIL</b>	3000 mm 22 / 66 RMT
<b>EXTERNAL CORNER</b>	3000 mm 12 / 36 RMT

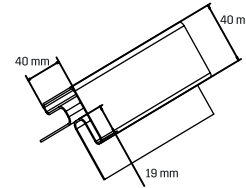
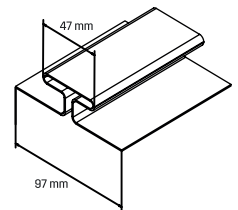
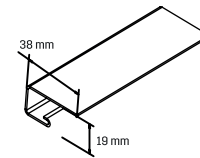
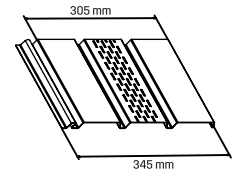
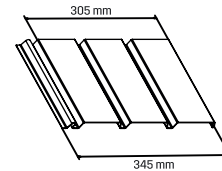

### AESTHETIC AND EASY TO INSTALL

A set of elements of the SOFFIT system, which enables efficient and aesthetic finishing of any type of roof eaves. The designed system ensures simple and quick assembly, regardless of the selected type of development.



### LIGHTWEIGHT STRUCTURE AND EFFICIENT INSTALLATION

The low weight of the PVC ROOF SOFFIT system [compared to steel and wooden systems] allows for efficient installation with additional decorative elements, e.g. lighting.



### DURABILITY AND RESISTANCE

Regardless of the weather conditions, PVC provides an aesthetic appearance, resistance to mould and fungi - without the need for maintenance.



### IT DOES NOT REQUIRE PAINTING AND MAINTENANCE

PVC retains its colour and board pattern without the need for renovation.

# Details matter - and we know it!

▮ PVC ROOF SOFFIT



# KROP®

SOFFIT SYSTEM



KROP®



## Traditional craftsmanship in a modern form

Production Plant  
Polanka 323, 32-400 Myślenice, Poland  
Phone: +48 12 37 31 666

Blachotrapez Sp. z o.o.  
ul. Kilińskiego 49a  
34-700 Rabka-Zdrój, Poland

